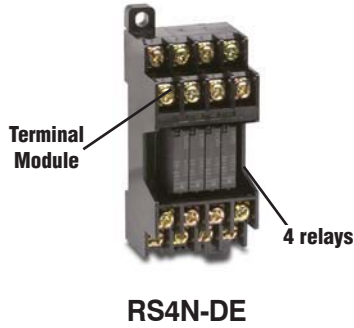


RS Series Electromechanical Relay Selection Guide



RS Series Card Relay Selection Guide			
Part Number	Price	Description	Dimensions and Wiring Diagrams
RS4N-DE	<-->	Card relay (4 relays included; 4 commons), mounted in socket, 24VDC coil, SPST, 5A rating. TY3 included.	Figure 3
RS6N-DE	<-->	Card relay (6 relays included; 2 commons; 3 relays per common), mounted in socket, 24VDC coil, SPST, 5A rating. TY3 included.	Figure 4
RB105-DE	<-->	Spare relays (package of 10) for the RS series Relays. 24V DC coil, SPST, 5A rating.	Figure 1
TY3	<-->	Relay remover for RS series relays. Package of 10.	-
RZ4N	<-->	Terminal guard for RS series relays. Package of 10.	Figure 2

RS Series Relay Specifications



RS6N-DE

RS series relays are compact, space-saving relay terminal modules containing four or six card relays with one normally open contact each. These relay-and-terminal modules are ideal for interfacing electronic control devices (such as PLCs or photoelectric sensors) with output devices.

Features:

- Compact size of 34 mm wide by 69 mm long, including screw terminals
- Input terminals are located in the upper part and output terminals in the lower part of the module to separate them from each other, making wiring easy
- RB105 plug-in relays and TP04 sockets make maintenance easy
- Built-in coil surge-suppression diodes and operation indicator LEDs simplify circuit design and maintenance
- The module is easily-mounted on a 35 mm DIN rail
- The RS4N module includes two standard accessory jumper plates, which are convenient for common wiring of terminals

RS4N-DE and RS6N-DE Series Card Relay Specifications Table

Contact		1 NO / SPST			
Contact Resistance		30m Ω or less (before use)			
Contact Material		Silver alloy (gold-plated)			
Min. Operating Voltage and Current		0.1VDC, 1mA			
Rated Thermal Current		5A			
Max. Make/Break Current		250VAC, 5A 30VDC, 5A			
Operating Time		10ms or less at rated voltage			
Release Time		10ms or less at rated voltage			
Insulation Resistance		100M Ω (at 500VDC megger)			
Dielectric Strength	Between Contact and Coil	2000VAC 1 minute			
	Between Contacts of Same Pole	750VAC 1 minute			
	Between Contacts of Different Pole	2000VAC 1 minute			
	Between Coils of Different Pole	500VAC 1 minute			
Vibration	Malfunction Durability	10 to 55Hz, 1mm double amplitude			
	Mechanical Durability	10 to 55Hz, 1.5mm double amplitude			
Shock	Malfunction Durability	100m/s ²			
	Mechanical Durability	1000m/s ²			
Life Expectancy	Mechanical	20 million operations			
	Electrical	Voltage	Make Current (A)	Break Current (A)	Operations
		220VAC (inductive load)	2 (cos θ = 0.7)	2 (cos θ = 0.3 - 0.4)	100,000
		220VAC (resistive load)	3 (cos θ = 1.0)	3 (cos θ = 1.0)	130,000
		24VDC (inductive load)	1 (T = 15ms)	1 (T = 15ms)	150,000
24VDC (resistive load)	5 (T = 1ms or less)	5 (T = 1ms or less)	100,000		
Ambient Temperature		-25 to + 55° C (no icing)			

Electromechanical Relay RB105-DE Specifications



RB105-DE

These spare relays are for replacement in RS4N-DE and RS6N-DE relay modules (5 mm). Bifurcated contacts ensure high contact reliability, allowing use in low-level circuits.

Features

- Narrow, miniature size and light weight reduces space on the DIN rail
- UL, CSA, CE, and TUV approved
- Low power consumption
- Can be operated with a non-polarity magnet
- Flux-tight construction

RB105-DE Card Relay Specification Table

Operating Time	10ms or less at rated voltage		
Release Time	5ms or less at rated voltage		
Insulation Resistance	100M Ω (at 500VDC megger)		
Dielectric Strength	750VAC 1 minute between open contacts 2000VAC 1 minute between contact and coil		
Impulse	4,500V or more 1.2 x 50 μ s between contact and coil		
Electrical Life Expectancy	AC: 100,000 operations at 220VAC 2A, inductive load 130,000 operations at 220VAC 3A, resistive load DC: 150,000 operations at 24VDC 1A, inductive load 100,000 operations at 24VDC 5A, resistive load		
Mechanical Life Expectancy	20 million operations		
Ambient Temperature	-40° C to +70° C (no icing)		
Contact Ratings	Voltage	Resistive load	Inductive load
	120VAC	-	1A
	240VAC	5A	-
	30VDC	5A	2A (15ms)
	120VDC	0.5A	0.2A (15ms)
Thermal Current	5A		
Make and Break Current (Resistive Load)	250VAC, 5A 30VDC, 5A		
Operating Coil	Rated voltage	24VDC	
	Pick-up voltage	70% of rated coil voltage	
	Drop-out voltage	5% of rated coil voltage	
	Power consumption	200mW	
	Coil resistance	2880 Ω	

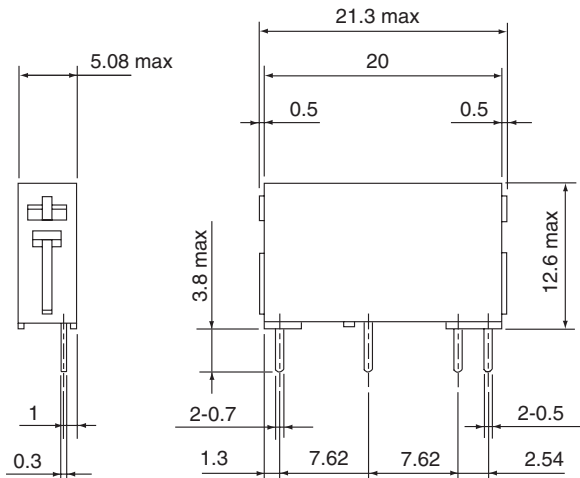
RS Series Relay Remover and Protective Cover

Relay remover, TY3

To remove a relay from the terminal module, use the TY3 relay remover. RS4N-DE and RS6N-DE modules include a TY3 relay remover. Pull the relay in a direction perpendicular to the terminal module surface. Incorrectly removing or mounting a relay may damage the relay pins and pin jacks of the module.

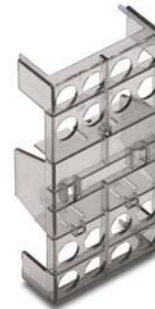


Figure 1 (Dimensions, mm)
RB105-DE

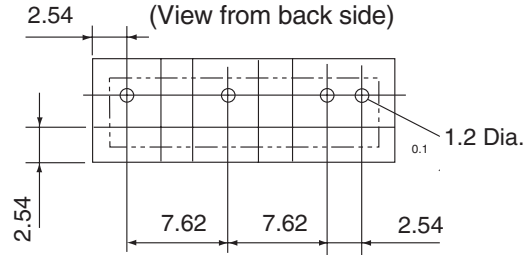


Optional protective cover, RZ4N

A protective cover fits over the RS4N-DE or RS6N-DE module and protects the terminals.



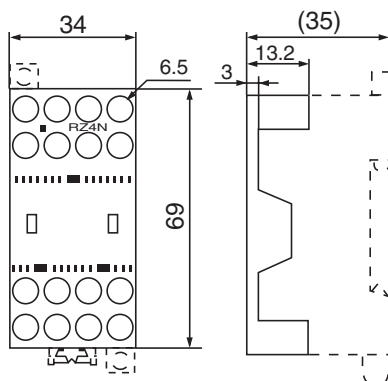
PC board drilling (View from back side)



Internal wiring diagram

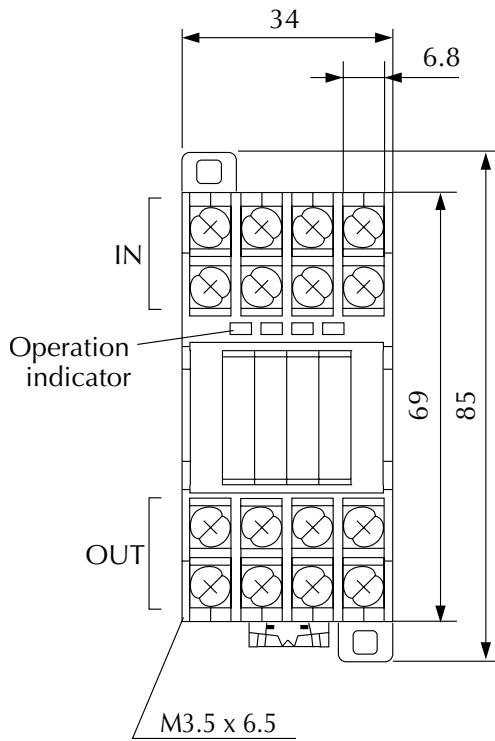


Figure 2 (Dimensions, mm)
RZ4N (Terminal guard for RS Series)

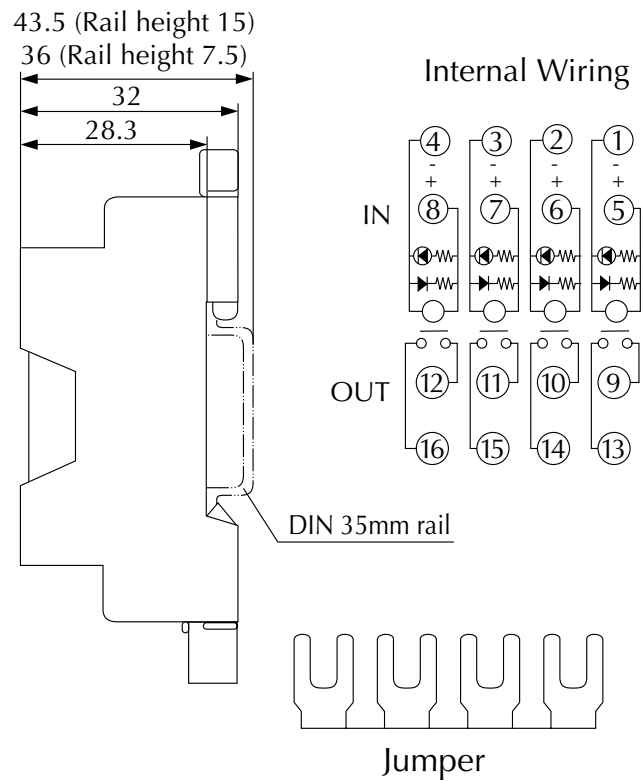


RS Series Relay Dimensions and Wiring Diagrams

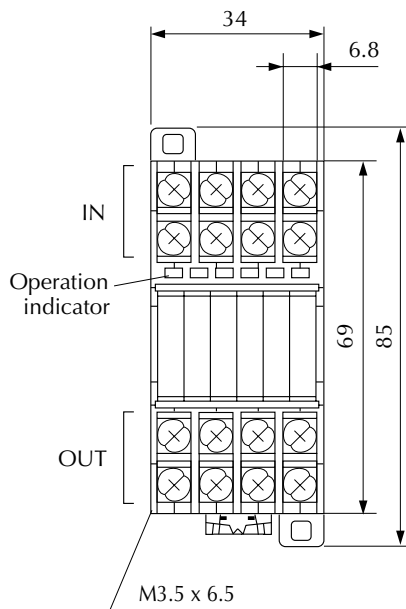
**Figure 3 Dimensions (mm)
RS4N-DE**



**Wiring diagram
RS4N-DE**



**Figure 4 Dimensions (mm)
RS6N-DE**



**Wiring diagram
RS6N-DE**

