

Wiring Duct – Accessories

Duct Separators

Duct separators allow the physical separation of circuits within a single piece of duct. The various mounting arrangements allow alternate compartmentalization of duct and differing ratios of usable sections.

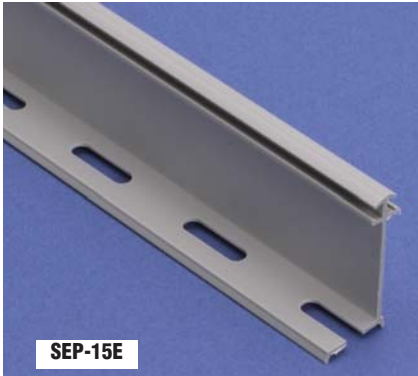

Duct Separators					
Part Number	Price	Description	Color	Standard Carton	
				Pcs/Pkg	Total Actual Length, ft/m
SEP-15E	<--->	Separator for 1.5" high duct, bulk pack	Gray	32	209.92 (64)
SEP-15E-1	<--->	Separator for 1.5" high duct	Gray	1	6.56 (2)
SEP-22E	<--->	Separator for 2.25" high duct, bulk pack	Gray	20	131.20 (40)
SEP-22E-1	<--->	Separator for 2.25" high duct	Gray	1	6.56 (2)
SEP-30E	<--->	Separator for 3.0" high duct, bulk pack	Gray	12	78.72 (24)
SEP-30E-1	<--->	Separator for 3.0" high duct	Gray	1	6.56 (2)

Note: Length of separators is 6.56' (2m).

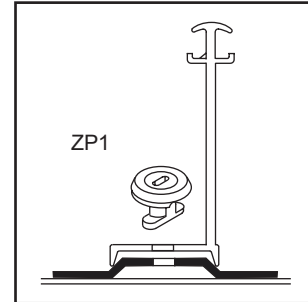

SEP-E Mounting detail

Wire Retainers

For holding wires during wiring operations, these retainers are essential. They allow easy access to the interior of the wiring duct during maintenance or alterations, while assuring that wiring bundles will not fall out when the duct cover is removed. Installed with a simple rotating movement, they anchor firmly in the recess boss in the duct base.

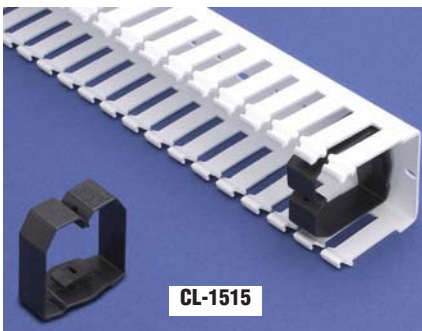

Wire Retainers				
Part Number	Price	Description	Color	Pcs/Pkg
CL-1515	<--->	Wire retainer fastener for 1.5" x 1.5" duct	Gray	40
CL-1522	<--->	Wire retainer fastener for 1.5" x 2.25" duct	Gray	40
CL-1530	<--->	Wire retainer fastener for 1.5" x 3.0" duct	Gray	20
CL-2215	<--->	Wire retainer fastener for 2.25" x 1.5" duct	Gray	40
CL-2222	<--->	Wire retainer fastener for 2.25" x 2.25" duct	Gray	20
CL-2230	<--->	Wire retainer fastener for 2.25" x 3.0" duct	Gray	20
CL-2240	<--->	Wire retainer fastener for 2.25" x 4.0" duct	Gray	20
CL-3015	<--->	Wire retainer fastener for 3.0" x 1.5" duct	Gray	20
CL-3022	<--->	Wire retainer fastener for 3.0" x 2.25" duct	Gray	10
CL-3030	<--->	Wire retainer fastener for 3.0" x 3.0" duct	Gray	10
CL-3040	<--->	Wire retainer fastener for 3.0" x 4.0" duct	Gray	10
CL-4015	<--->	Wire retainer fastener for 4.0" x 1.5" duct	Gray	10
CL-4022	<--->	Wire retainer fastener for 4.0" x 2.25" duct	Gray	10
CL-4030	<--->	Wire retainer fastener for 4.0" x 3.0" duct	Gray	10
CL-4040	<--->	Wire retainer fastener for 4.0" x 4.0" duct	Gray	5
CL-6040	<--->	Wire retainer fastener for 6.0" x 4.0" duct	Gray	5

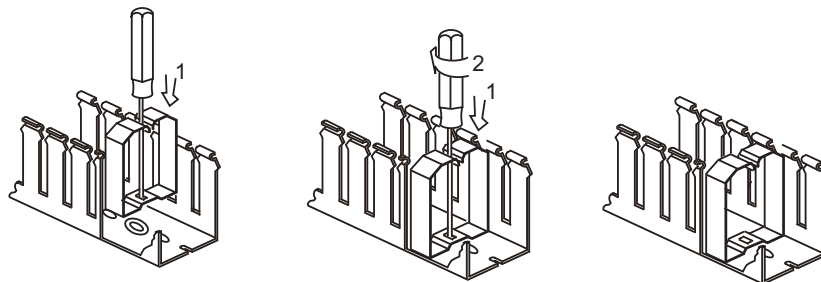
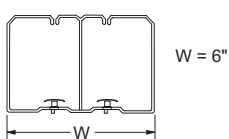
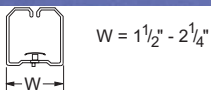

Wiring Duct – Accessories

Duct Marking Tags			
Part Number	Price	Description	Pcs/Pkg
DM1	<--->	Single-width white cardboard identification label for wiring duct. Supplied with black plastic mounting clip and transparent plastic cover slide	50

Note: DM1 marking tags can only be used with T1 series wire duct.

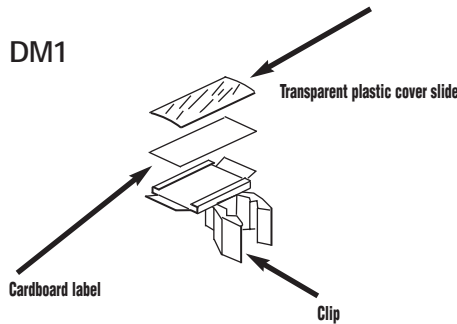

Identification Tags

Allowing easy identification of control gear and switchgear, these tags are mounted by snapping the clip onto the sidewall finger segments of the duct. No gluing - no drilling! After installation, they need not be removed during maintenance or any work which involves the removal of the covers.

Note: Take care that clip is installed above the wires coming out to the sidewall slots.

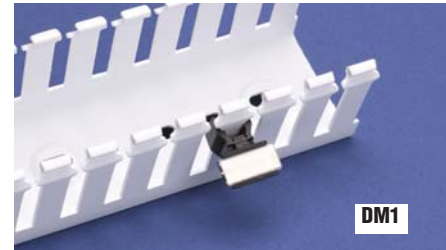

Mounting Devices			
Part Number	Price	Description	Pcs/Pkg
ZP1	<--->	Round, white polyamide 'button' used to mount components and separators inside duct.	100
ZP2	<--->	Square white polyamide cable tie mount used to tighten a wire bundle inside duct.	50

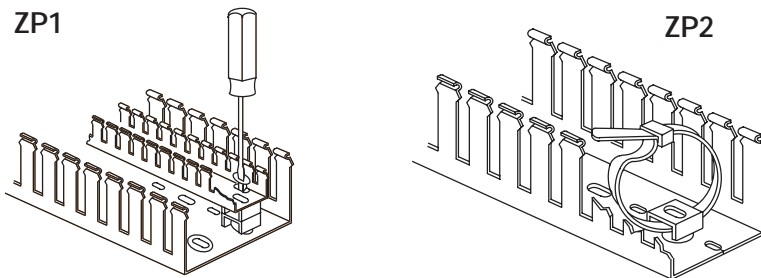

Mounting Inserts

We carry mounts in two styles: ZP1 for mounting components and SEP-E separators inside duct, or for mounting small sizes of duct inside larger sizes (for separation of circuits with different functions); and ZP2, which is used with a cable tie to secure a wire bundle inside the duct.



Wiring Duct Rivets and Rivet Tools			
Part Number	Price	Description	Pcs/Pkg
R4	<--->	Blue polyamide rivet used to install all types of wiring duct with standard 5/32" (4 mm) mounting holes.	250
B4	<--->	Red polyamide rivet tool used to install R4 rivets.	1
R6	<--->	Natural polyamide rivet used to install all types of wiring duct with standard 7/32" (5.5 mm) mounting holes.	250
B6	<--->	Yellow polyamide rivet tool used to install R6 rivets.	1

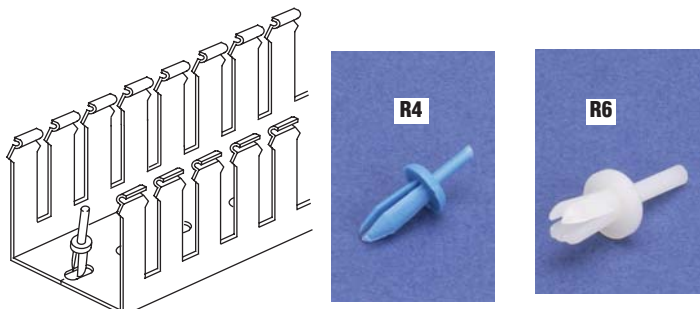

Rivets and Rivet Tools

Wiring duct rivets install quickly and easily with the companion rivet tool, offering good temperature resistance and excellent mechanical properties. They can be used to install all types of wiring duct with standard mounting holes.

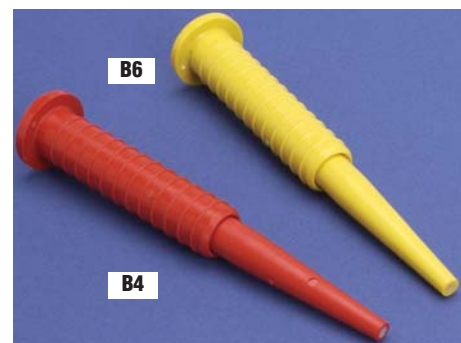

Wiring Duct – Accessories

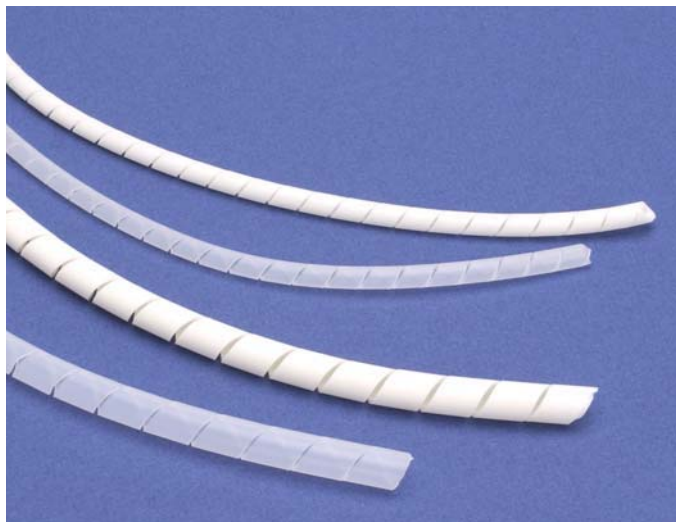

Spiral Wrap

For neatly grouping wire bundles simply and economically, spiral wrap has no equal. Strong, yet easy to install, it protects the wire bundle, keeping it flexible though tightly contained. It is easily removed and reusable for temporary wiring.

Dimensions

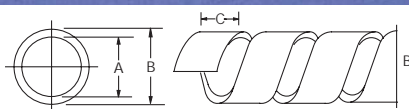

Catalog Number		Dimensions in Inches			Wire Bundle Size in Inches	Feet per Carton
Polyethylene	Flame-retardant Polyethylene (meets UL 94V-2)	A	B	C		
P-1	PA1	.06	.12	.20	1/16 to 1/2	160
P-2	PA2	.16	.24	.31	¼ to 2	80
P-3	PA3	.31	.39	.47	3/8 to 3	80
P-4	PA4	.35	.47	.47	½ to 4	65

Spiral Wrap				
Part Number	Price	Description	Color	Length
P-1	<-->	0.125" nominal o.d. Polyethylene spiral wrap used for wire bundles from 1/16 to 1/2 inch diameter.	Natural	160 ft./pack
PA1*	<-->	0.125" nominal o.d. self-extinguishing Polyethylene spiral wrap used for wire bundles from 1/16 to 1/2 inch diameter.	White	160 ft./pack
P-2	<-->	0.25" nominal o.d. Polyethylene spiral wrap used for wire bundles from 1/4 to 2 inch diameter.	Natural	80 ft./pack
PA2*	<-->	0.25" nominal o.d. self-extinguishing Polyethylene spiral wrap used for wire bundles from 1/4 to 2 inch diameter.	White	80 ft./pack
P-3	<-->	0.375" nominal o.d. Polyethylene spiral wrap used for wire bundles from 3/8 to 3 inch diameter.	Natural	80 ft./pack
PA3*	<-->	0.375" nominal o.d. self-extinguishing Polyethylene spiral wrap used for wire bundles from 3/8 to 3 inch diameter.	White	80 ft./pack
P-4	<-->	0.5" nominal o.d. Polyethylene spiral wrap used for wire bundles from 1/2 to 4 inch diameter.	Natural	65 ft./pack
PA4*	<-->	0.5" nominal o.d. self-extinguishing Polyethylene spiral wrap used for wire bundles from 1/2 to 4 inch diameter.	White	65 ft./pack

*Note: PA series white spiral wrap meets UL 94V-2 specification

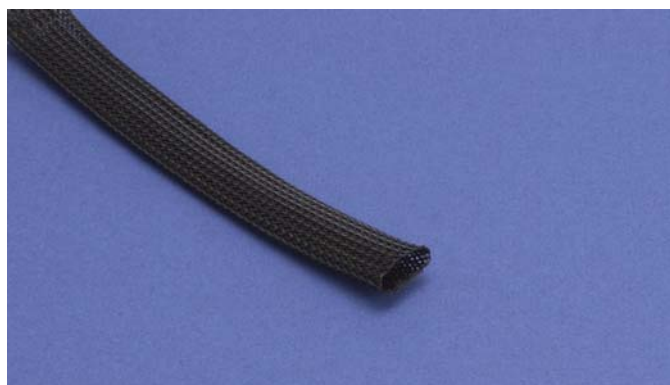

Braided Sleeving

This lightweight, expandable, self-extinguishing polyester sleeving has an open weave to allow maximum diameter expansion. It is super-flexible and easy to install, gripping objects of various shapes and sizes reliably. Abrasion-resistant, it provides extra protection against chemicals and flame.

Braided Expandable Sleeving Material Specifications	
Operating Temp	-50°C to +150°C (-58°F to +302°F)
Physical Properties	Self-extinguishing for UL 94V-2
Maximum Elongation	42%
Diameter Expansion	100%
Other	Halogen-free

UL 94V-2 Expandable Sleeving				
Part Number	Price	Description	Color	Length
TY-5	<-->	Braided expandable polyester sleeving, 0.197"(5mm) nominal i.d., 0.157"(4mm) to 0.472"(12mm) nominal range	Black	325 ft./pack
TY-10	<-->	Braided expandable polyester sleeving, 0.375"(10mm) nominal i.d., 0.315"(8mm) to 0.866"(22mm) nominal range	Black	325 ft./pack
TY-20	<-->	Braided expandable polyester sleeving, 0.750"(20mm) nominal i.d., 0.630"(16mm) to 1.378"(35mm) nominal range	Black	164 ft./pack
TY-30	<-->	Braided expandable polyester sleeving, 1.125"(30mm) nominal i.d., 0.984"(25mm) to 1.890"(48mm) nominal range	Black	164 ft./pack
TY-50	<-->	Braided expandable polyester sleeving, 2.0"(50mm) nominal i.d., 1.575"(40mm) to 2.825"(72mm) nominal range	Black	164 ft./pack